

45A
Drilling Attachment

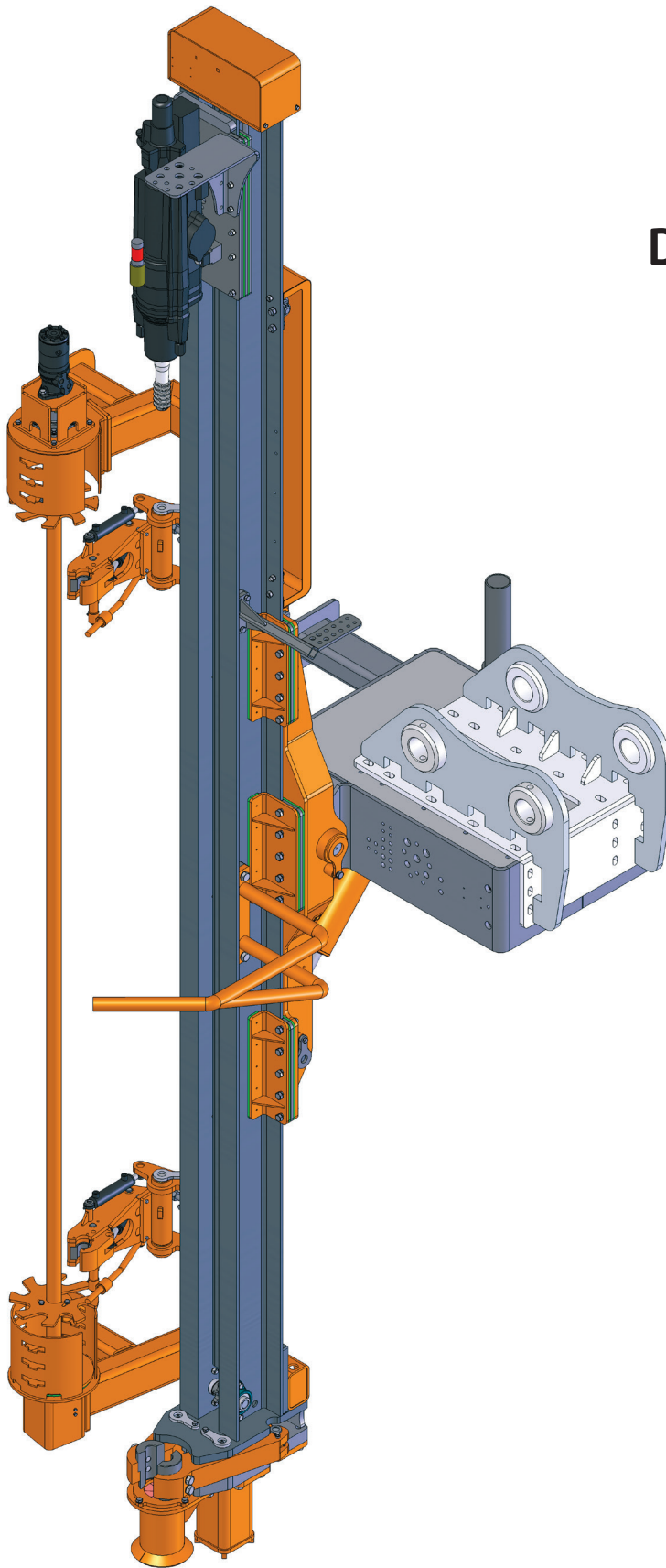

Drifter

Manufacturer		Doofer
Type		DF560L
Impact power	kW	20
Max input power to rock drill	kW	33
Impact energy	J	260
Hydraulic pressure, max	bar	170
Torque, max	Nm	1170
Impact frequency	Hz	55 - 67

Dimensions and weights

Weight	kg	2600 (w/o coupling)
Length	mm	6200
Width	mm	2500 + 200
Height	mm	1600 (w/o coupling)

Drill Steel

Hole range	mm	51 - 89
Drill steel		R32/T38/T45

Dust collector

Model		HSL900
Filter area	m ²	14,4
Number of filter elements	pcs	12
Suction capacity (max. nominal)	l/s	800
Suction hose diam	mm	127
Cleaning air pressure, max	bar	7
Cleaning air consumption	l/pulse	40

Compressor

Type		Screw
Model		PTR60
Capacity	lpm	6000
Working pressure	bar	7

Feed system

Feed extension	mm	1000
Feed force, max	kN	19
Tractive pull, max	kN	19
Total length	mm	6100
Travel length	mm	4270

AutoDrill drilling automatic system

Pressure adjustments during drilling	standard
X / Y angles with lights and numbers	standard
Penetration rate	standard
Hole depth	standard
Stop depth form surface	standard
Stop depth from laser level	option
Reading of hydraulic oil temperature	standard

Accessories

Boom camera	option
Laser receiver	option
Central lubrication system	option
Extra mounting kit for additional excavator	option
GPS system	option

Hydraulic system

Controls	AutoDrill automatic drilling with CAN-control from excavator cabin
Anti-jamming	Anti-jamming integrated in AutoDrill automatic drilling in all models
Oil cooling	Cooler for compressor motor return flow is available

Carrier requirements

Weight	tn	24 - 40
Flow / pressure for drilling	LPM @ Bar	230 @ 150
Flow / pressure for compressor	LPM @ Bar	145 @ 150
Flow / pressure for dust collector	LPM @ Bar	50 @ 150
Total flow / pressure; min	LPM @ Bar	290 @ 150
Total flow / pressure; max	LPM @ Bar	425 @ 150
Power requirement for engine	kW (min/max)	95 /135