

Junttan

Pile Driving Rig

PMx28

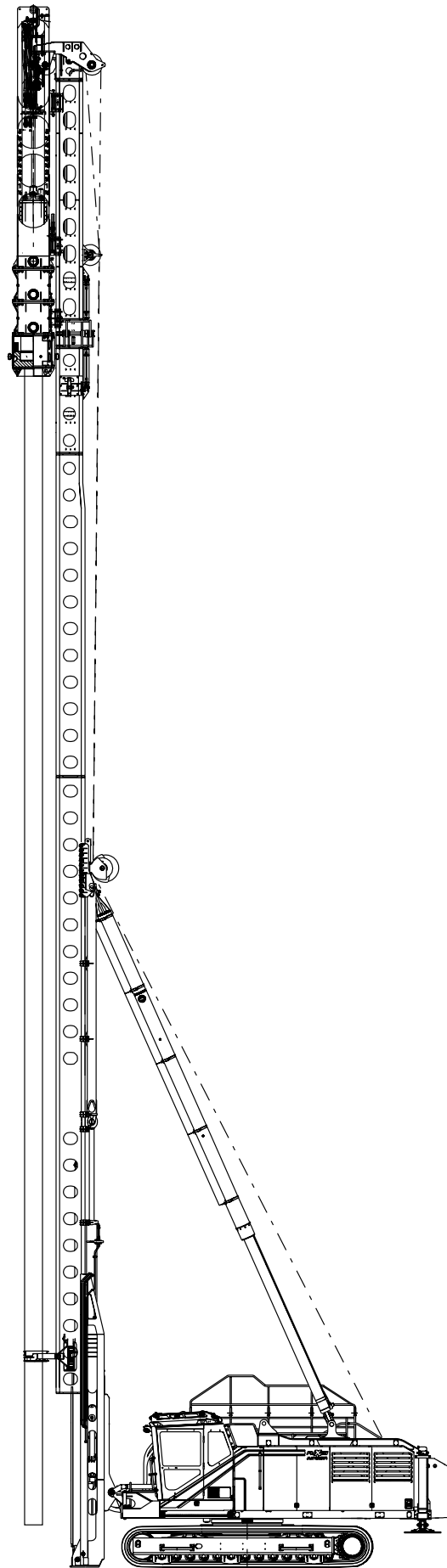

Original
Junttan
product

DATA SHEET

General Information

Junttan PMx28 is a medium weight piling rig designed for driving steel and concrete piles. PMx28 is Junttan's biggest pile driving rig with telescopic leader for extremely efficient and more powerful heavy duty use. The rig has excellent stability and wide leader inclination angles. The recommended hammer size is from 5 000 to 9 000 kg and the maximum pile length is 28 meters (91 ft) with Junttan SHK110-5 hammer. The rig has proven productivity and the telescopic leader ensures easy and fast handling of piles. Top pile driving performance is guaranteed with Junttan hydraulic hammers. An optional side drill makes pile driving even more efficient in some soil conditions. With optional Junttan equipment, optimised working set-up of the rig can be easily achieved.

This Junttan piling rig has all proven features of Junttan X-series and it comprises a number of new technologies to minimize the fuel consumption and environmental impact. Its rugged design makes it a safe and reliable rig even in the most demanding working conditions. The self-erecting leader and many advanced technical features ensure that the rig is ready to work in just a few minutes. The ergonomic and safety tested cabin allows the driver to concentrate completely on his work. The expandable tracks and low center of gravity make the rig exceptionally stable in different working situations. The horizontal movement of the leader and a full 360 degree working radius ensures fast spotting of the pile. In spite of larger size the rig can be still easily transported to a new working site.

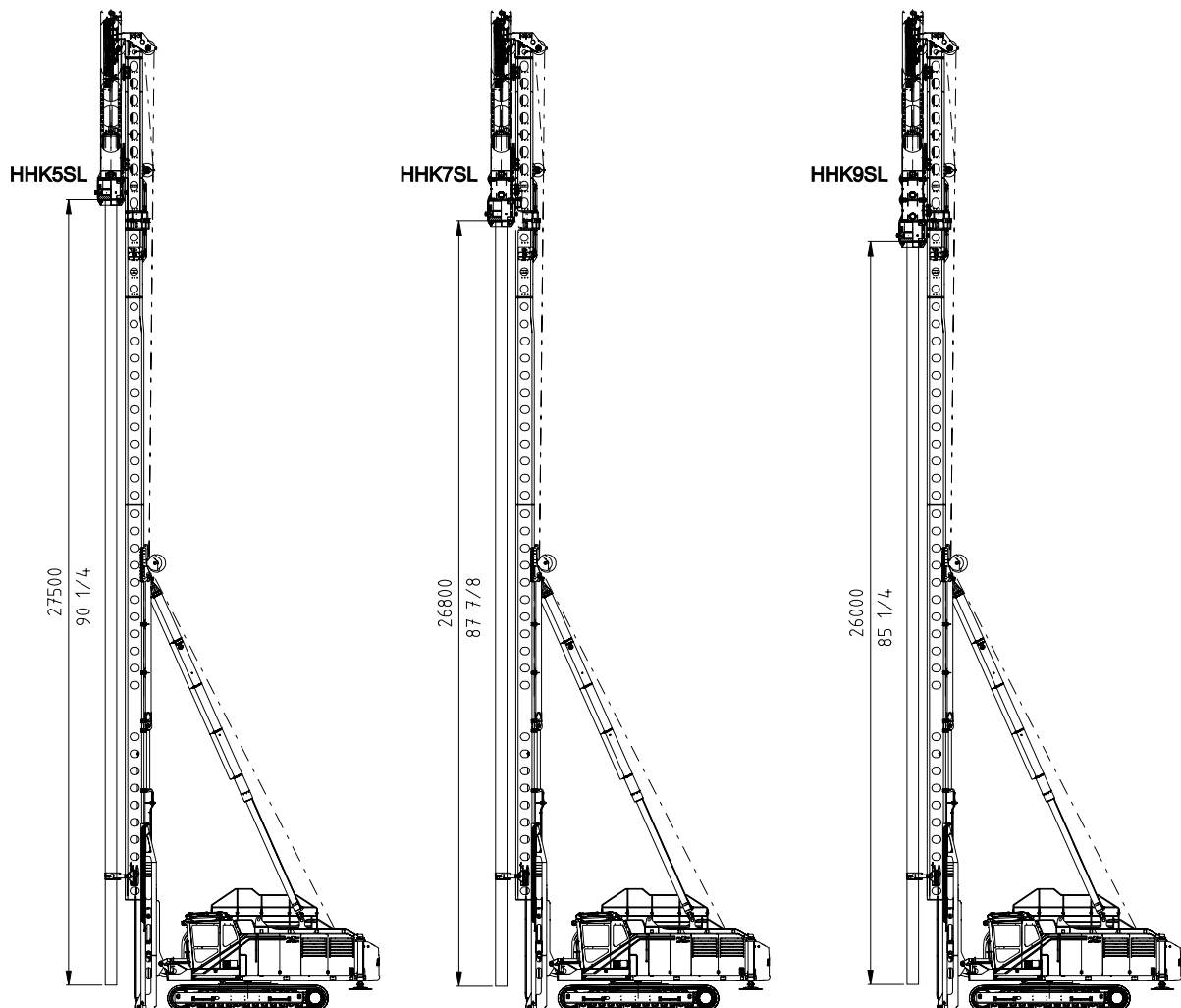

PMx28 with HHK5SL / HHK7SL / HHK9SL hammer options

* Pile length depends on the hammer. See the table of hydraulic hammers beside.

Technical Data

Basic features

Nominal operational weight		90 000 kg	198 000 lb
Maximum leader capacity		30 000 kg	66 100 lb
Winch capacity	Pile:	12 000 kg	26 400 lb
	Hammer:	20 000 kg	44 000 lb
	Auxiliary:	5 000 kg	11 000 lb
Recommended hammer type		SHK110-5/7/9	
Maximum pile length (HHK 5SL)		28 m	91 ft

Uppercarriage

Type	Junttan PMx28		
Engine	Type:	Cummins QSL9	E4 Stage IV / US EPA Tier 4F
	Power:	283 kW	384 hp
	Fuel tank:	810 liters	212 gal
Hydraulic system	Max flow:	2x280 + 120 lpm/2 000rpm	2x74 + 32 gpm/2 000rpm
	Max pressure:	350 bar	5 075 psi
	Cooling system:	2xHPA52 coolers	
	Oil tank:	750 liters	196 gal
Control system	Junttan X control system		
Slew drive	Single drive, 1 600 mm single row slewing ring		
Counterweight	Extendable	5 500 + 4 500 + 2 000 kg	12 100 + 9 900 + 4 400 lb

Leader

Type	Telescopic PMx28		
Movements	Telescope	4 000 mm	158 in
	Foot (up/down)	1 000/500 mm	40/20 in
	Horizontal	1 500 mm	59 in
Inclinations	According separate capacity tables Electronic inclinometer included		

Undercarriage

Type	JH57160		
Crawler length		5 700 mm	225 in
Crawler type		D7A	
Width (900 shoes)	Min:	3 380 mm	133 in
	Max:	4 880 mm	192 in
Track shoe options	Width:	800/900/1 000 mm	31½/35½/39½ in
	Surface:	3-edge / flat edges / flat	
	Edge type:	normal / chamfer / bended	

Accessories

* Side cathead		* iPiler PCD
* Side auger JD1,5/JD3		* Air conditioning
* Rear support legs		* Auxiliary winch (5 000 kg / 11 000 lb)
* Automatic central lubrication		* Generator
* Arctic kit		* Air compressor

* Contact Junttan sales for all available options and accessories

Transport Dimension

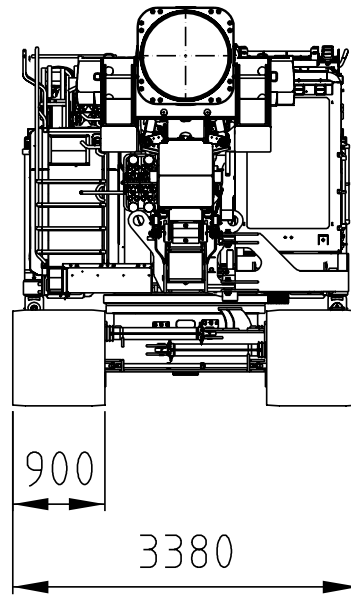

Minimum track width.

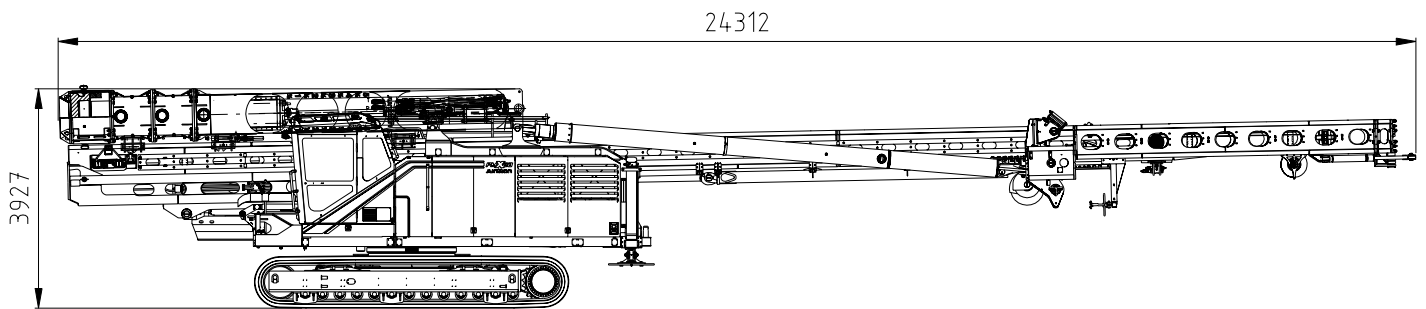

PMx28 transport dimensions with longest available leader configuration (Hydraulic Impact Hammer HHK 5SL).
Leader hinge is optional.

Junttan

Junttan Oy
P.O. Box 1702 (Matkusentie 7)
FI-70701 KUOPIO, Finland

Tel. +358 10 195 221
Fax +358 17 287 4411
junttan@junttan.com